

ROMAN SHADES

Cordless

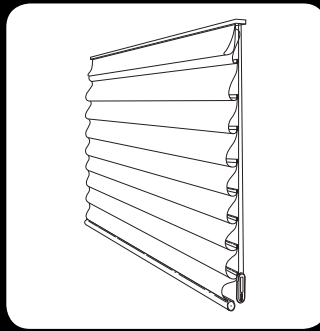

3DAYBLINDS®
YOU'LL LOVE THE TREATMENT

GETTING STARTED

A few simple tools are required:



Steel Tape Measure



Pencil

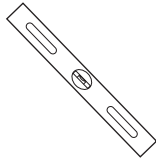

Level
(for outside mount)



Power Drill and
Drill Bits



Flathead & Phillips
Screwdriver



Awl (or tool for starting
a screw hole)

Included in your order is all the hardware necessary for a normal installation. Depending on the mounting surface, fasteners other than the screws provided may be required. Wall board and plaster require the use of anchors such as expansion or toggle bolts. Bricks, tile and stone need special plugs and drill bits. Wood should always be pre-drilled to avoid splitting.

Professional installation is also available in most areas, call 800-800-3329.

STANDARD HARDWARE

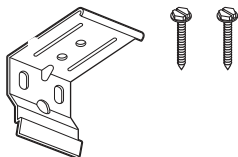

OPTIONAL HARDWARE

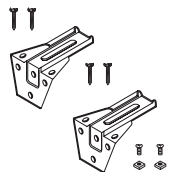

Extension Brackets
with Nuts and Bolts



Spacers

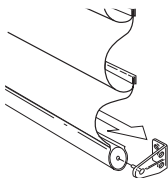

Hold Down Brackets
with Screws

BRACKET INFORMATION

The brackets you received with your product are REQUIRED for proper installation. Brackets should be installed at each end and any additional brackets will need to be evenly spaced between the two end brackets.

INSIDE MOUNT

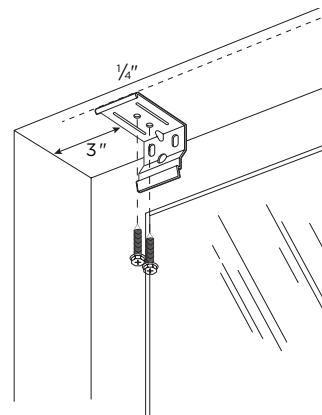

- Shade brackets should be installed 3" in from each corner of the window.
- Mount 1/4" back from the front edge of the window casing.
- Additional brackets, if included, are REQUIRED for proper installation and should be installed evenly spaced between the two end brackets.

- Proceed to "Shade Installation".

OUTSIDE MOUNT

NOTE: You will be using your shade with mounting brackets attached to the headrail to mark the position of the brackets on your wall or molding. DO NOT CUT the cellophane wrapping as the fabric or the cords supporting the shade may be inadvertently cut. Unwrap the cellophane and unwind the cords from around the headrail.

- Attach brackets to the headrail 3" from each end. Additional brackets, if included, are REQUIRED for proper installation and should be spaced evenly over the width of the headrail. Lower the shade to it's full length. (See "Shade Operation".)

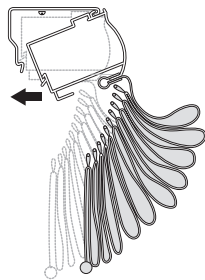

NOTE: If using extension brackets, attach mounting brackets to extension brackets with nuts and bolts before attaching brackets to headrail. (See "Optional Accessories".)

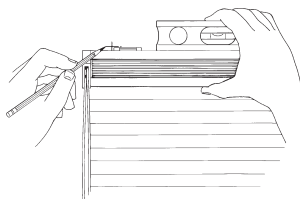

- Hold the shade up to the desired mounting position over the window. Once the shade is level, mark the wall or molding on either side and top of each mounting bracket.

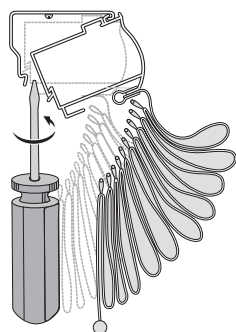

- Remove bracket by using a flat head screw driver and push up between racket and head rail.

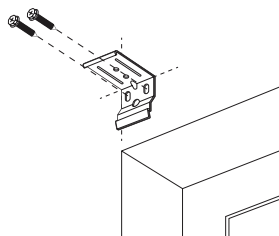

- Fasten brackets to wall where marked.
- 1" of flat mounting surface is required to mount your MiniCell Honeycomb Shade, Micro or 1" Pleated Shade.
- 5/8" of flat mounting surface is required to mount your MidCell, TwinCell or GrandCell Honeycomb Shade.

- Proceed to "Shade Installation".

END MOUNT

An end mount is recommended for shades being installed with an arch top or for inside mount applications where there is no alternative mounting surface.

NOTE: You will be using your shade with mounting brackets attached to the headrail to mark the position of the brackets in your window opening. DO NOT CUT the cellophane wrapping as the fabric or cords supporting the shade may be inadvertently cut. Unwrap the cellophane and unwind the cords from around the headrail.

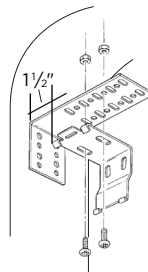

Attach the mounting brackets to each extension bracket using the holes indicated in the diagram. Attach brackets to the headrail 1 1/2" from wall. Lower the shade to it's full length. (See "Shade Operation".)

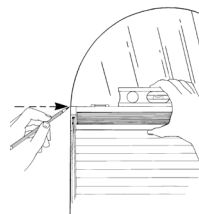

- With the mounting brackets attached, hold the shade up to the desired mounting position inside the window casing.

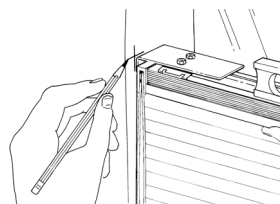

- Once the shade is level, recess the shade 1/4" from the front edge of the window casing and mark the wall on the front side and top edge of each extension bracket.

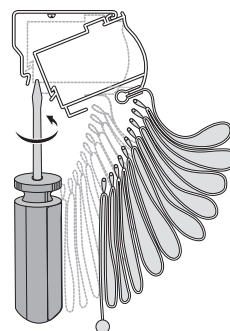

- Remove bracket by using a flat head screw driver and push up between racket and head rail.

NOTE: Diagram does not show extension bracket.

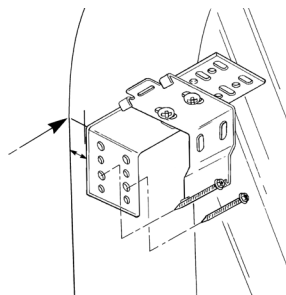

- Install an assembled end mounting bracket at each set of marks in your window opening.

SHADE INSTALLATION

- If you have not already done so, unwrap the cellophane from around the shade. DO NOT CUT the cellophane as the fabric or the cords supporting the shade may be inadvertently cut. Also, unwind the shade cord and let it hang down in front of the shade.
- With the front of the shade facing you, hold the shade up to the mounting brackets and insert the back lip of the shade into the bottom groove on the bracket.

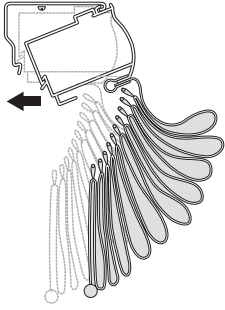

- Rotate the headrail up and back until it snaps into place.

SHADE OPERATION

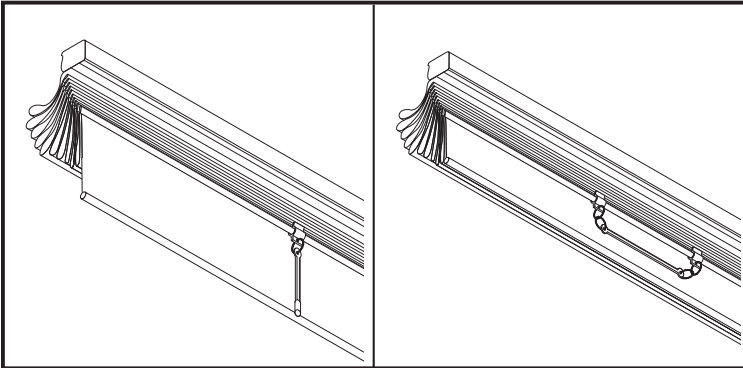

To raise shade, grasp handle(s) and push up.

SHADE REMOVAL

- Draw the shade completely up. (See “Shade Operation”)
- While pinching the headrail and bottom rail together with both hands, gently but firmly rotate the headrail back and forward until the front of the headrail releases from the mounting brackets.

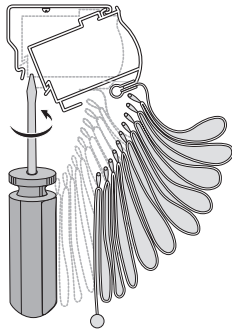

- Rotate the headrail up and back until it snaps into place.

OPTIONAL ACCESSORIES

EXTENSION BRACKETS

Extension Brackets are used to project the shade up to 3” from the mounting surface. Extension brackets are available at an additional charge and are ideal if your shade must clear an obstruction such as a sliding glass door handle or window crank. Extension brackets require a flat vertical mounting surface of at least 7/8”.

To assemble and mount

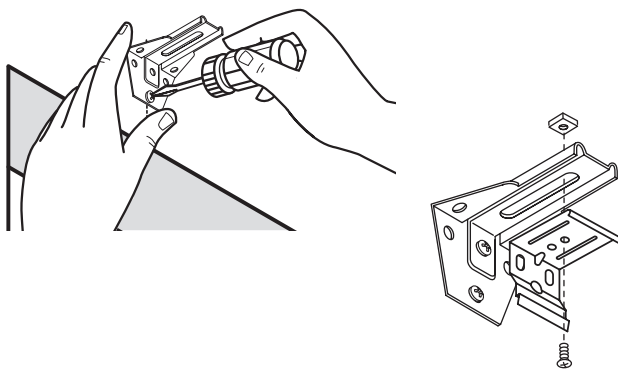

- Attach each mounting bracket to an extension bracket by using the nuts bolts and washers provided.
- Mount the extension bracket to the wall per the instructions for an “Outside Mount”, using a level and making certain that all mounting brackets are level and project the same distance from the mounting surface. For maximum stability, install the screws diagonally from one another.
- Install the shade per the directions for “Shade Installation”.

SPACERS

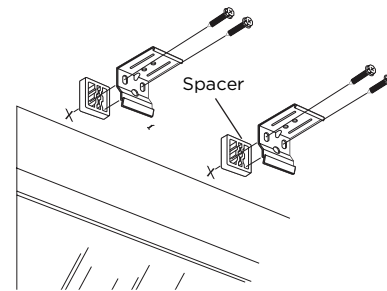

Spacers are available for use on windows with a projected molding. They are 3/8” thick and allow the shade to be mounted flush with the outside edge of any standard window molding. They are available by contacting our Customer Care Department at 800-800-3329.

HOLD DOWN BRACKETS

Hold down brackets are used primarily on shades mounted to doors or in motor homes. There are two small holes in the end caps that are covered by a thin plastic layer. Use the pin on the hold down bracket to push through the center of the end cap and it will break through the plastic layer.

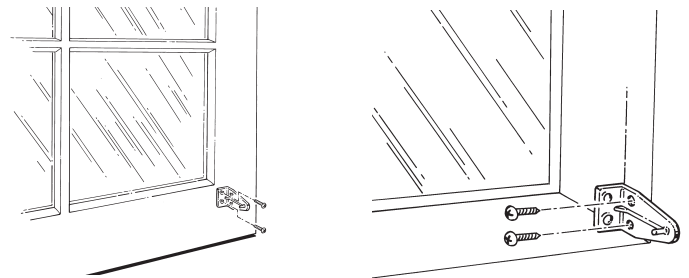

- With the shade lowered to it’s full length, place the pin of each hold down bracket into the hole in each end of the bottom rail.
- Mark the mounting surface, either to the side or back of the window frame, through the holes in the hold down bracket. Make sure the hold down brackets are level and aligned with each other.
- Raise the shade and screw the hold down brackets into the mounting surface using the screws provided.

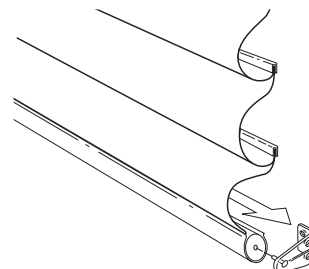

- Lower the shade and flex the hold down bracket outward so that the pin can be inserted into the hole in the end cap.

 **WARNING**

This product contains accessible cords on the back. Accessible cords on the back of Roman Style shades can be pulled out to form a loop, which can STRANGLE a young child.



- Children can climb furniture to access lift cords. Move cribs, playpens, and other furniture away from window coverings.

ANSI/WMCA A100.1-2012 5.2.9



3DAYBLINDS®
YOU'LL LOVE THE TREATMENT

800-800-3329 | 3dayblinds.com

Part # PM-035 © 3 Day Blinds Corporation 3/13