

## **! WARNING**

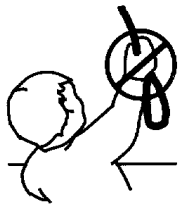

Young children can STRANGLE in cord and bead chain loops. They can also wrap cords around their necks and STRANGLE.

- Always keep cords and bead chains out of children's reach.
- Move cribs, playpens and other furniture away from cords and bead chains. Children can climb furniture to get to cords.
- Do not tie cords together. Make sure cords do not twist together and create a loop.

# Ultima® Mini Blind Installation Instructions

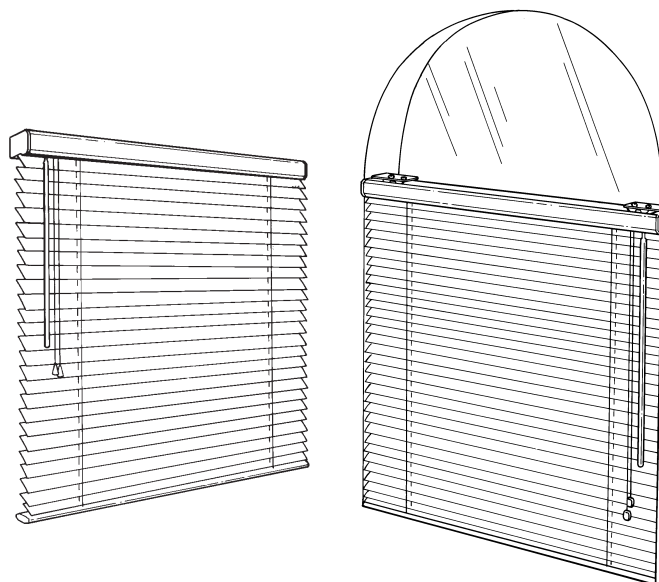

## Limited Lifetime Warranty

3 Day Blinds, Inc., will repair or replace any part of the blind found to be defective in materials or workmanship at no cost to you. This warranty is limited to the original consumer purchaser of the blinds. There is no time limit to our warranty, excluding Essentials® line products which come with a 1 year limited warranty. This warranty does not apply to any defect caused by improper installation, alteration, abuse, misuse or exposure to excess moisture. This warranty does not cover normal wear and tear such as the natural deterioration of fabric and changes in color that take place over time. This warranty does not cover products that exceed 3 Day Blinds' size recommendations. To obtain service, bring the product(s) in question to any 3 Day Blinds showroom with this warranty and your purchase invoice. This warranty gives you specific legal rights and you may also have other rights which vary from state to state.

*Ultima®*

Congratulations on the purchase of your new Ultima® Mini Blind. These blinds feature a new "hidden mounting bracket" system. When mounted properly, the mounting bracket will disappear from view giving your mini blind a smooth, clean look.

Included with your purchase is all of the hardware you will need to successfully install your new blind. This mounting system requires you follow these installation instructions to ensure a lifetime of trouble free performance.

# **3 DAY BLINDS®**

*America's Window Covering Specialists® Since 1978*

1-800-800-3DAY

[www.3day.com](http://www.3day.com)

PART #000-028 REV 12-02  
© COPYRIGHT DECEMBER 2002  
3 DAY BLINDS, INC.

# **3 DAY BLINDS®**

*America's Window Covering Specialists® Since 1978*

1-800-800-3DAY

[www.3day.com](http://www.3day.com)

# Getting Started

## A few simple tools are required:

- Steel tape measure
- Power drill and drill bits (if desired)
- Flathead and Phillips screwdriver
- Pencil
- Level (for outside mount)
- Awl (or tool for starting a screw hole)

Included in your order is all the hardware necessary for a normal installation. Depending on the mounting surface, fasteners other than the screws provided may be required. Wall board and plaster require the use of anchors such as expansion or toggle bolts. Bricks, tile or stone need special plugs and drill bits. Wood should always be pre-drilled to avoid splitting.

Professional installation is also available at most 3 Day Blinds locations.

## Standard Hardware

Inside Mounting Bracket

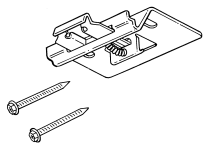

Outside Mounting Bracket

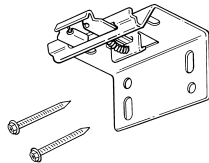

(over 60" wide 4 screws per bracket supplies)

## Optional Hardware

Hold Down Bracket

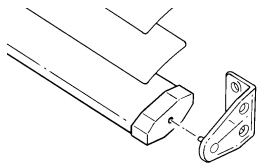

End Mount Bracket

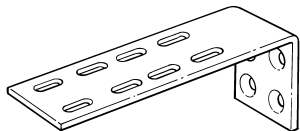

Hex Machine Nuts



Phillips Machine Screws



Phillips Flat Head Wood Screws

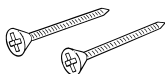

Spacers

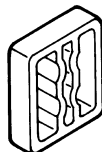

(2 Spacers per Bracket)

# Bracket Information

Blind Width	Number of Brackets
10" - 44"	2
44 1/8" - 67"	3
67 1/8" - 92"	4
92 1/8" - 120"	5

## Inside Mount

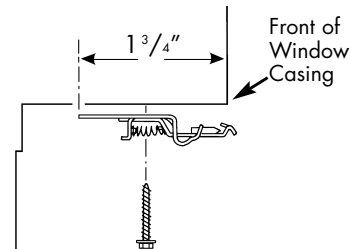

- 1 3/4" of window opening depth is required to mount an Ultima Mini Blind.

The back of the bracket must not be mounted any further back than 1 3/4" from the front of the window casing. The front of the bracket will extend slightly beyond the front of the window casing when installed correctly. Templates have been provided to assist with placement of the brackets.

Select the template that corresponds with the size of the blind you purchased.

Blind Width	Template
10 1/2" - 13"	A
13 1/8" and up	B

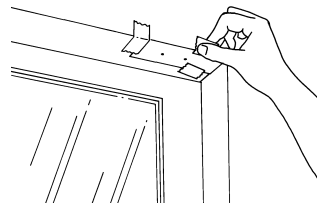

- Cut out the appropriate template for the size of your blind.
- Align the template along the front edge and inside corner of window casing.
- Tape template in place.

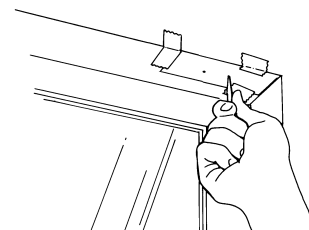

- Create small pilot holes with an awl or 1/16" drill bit.

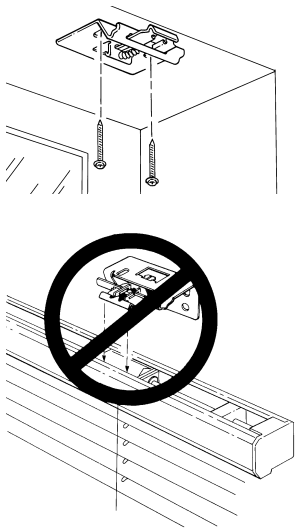

- Mount each bracket with two screws.
- Additional mounting brackets, if required, should be evenly spaced between the two end brackets.
- Align the same template along front edge of the window casing to determine mounting position for additional brackets.
- Make sure brackets do not interfere with any moving parts in the headrail.

Proceed to "Blind Installation".

## Inside Mount with End Brackets

NOTE: An end mount is recommended only when there is no alternative mounting surface available.

You will be using your blind with mounting brackets attached to the headrail to mark the position of the brackets inside your window casing (no template required). Bolt the inside mount brackets to each end mount bracket with the nuts and bolts provided to create a left hand bracket and a right hand bracket. Use appropriate holes as shown below.

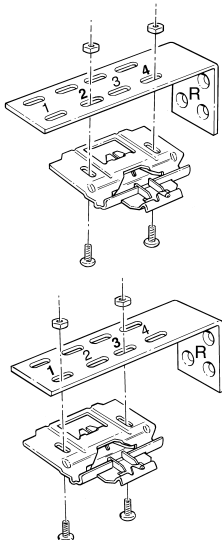

- For Blind width of 10 1/2" to 13" use second and fourth holes of the end mount bracket.
- For Blind width of 13 1/8" and over use first and third holes of the end mount bracket.

Attaching brackets to headrail is described in "Blind Installation".

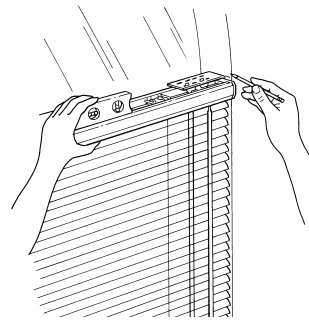

- Lower the blind to its full length. (see "Blind Operation")
- Hold the blind up to the desired mounting position in the window casing.
- Once the blind is level, mark the wall or molding on the top edge of each mounting bracket.

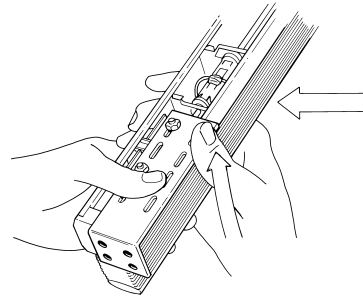

- Remove the mounting brackets from the headrail by pushing the back of the bracket forward and up with your thumb.

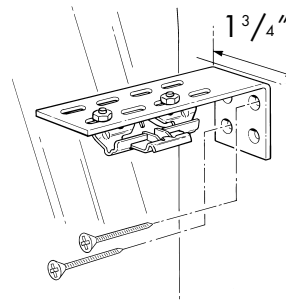

- Recess the back of the bracket no more than 1 3/4" from the front edge of the window casing.

For maximum stability the screws should be installed diagonally. Proceed to "Blind Installation".

## Outside Mount

1 1/4" of flat mounting surface is required to mount your Ultima Mini Blind.

You will be using your blind with mounting brackets attached to the headrail to mark the position of the brackets on your wall or molding. To determine bracket placement, you will need to make a small pencil mark on the **back of the headrail** at either 2" or 2 3/4" from the end of the headrail:

Blind Width	Mark Headrail
10 1/2" - 13"	2" from each end
13 1/8" and over	2 3/4" from each end

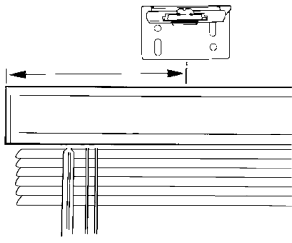

- Center a bracket over each pencil mark on the headrail.

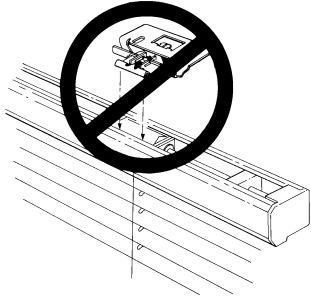

- Additional mounting brackets, if required, should be evenly spaced between the two end brackets.
- Make sure brackets do not interfere with any moving parts in the headrail.

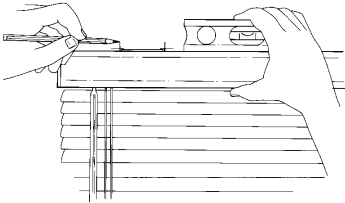

- Hold the blind up to the desired mounting position over the window. Once the blind is level, mark the wall or molding on either side and the top edge of each mounting bracket.

NOTE: If using extension brackets, attach mounting brackets to extension brackets with nuts and bolts before attaching brackets to headrail.

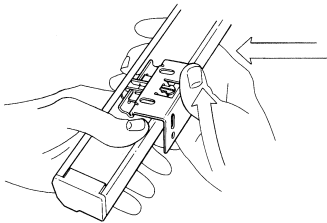

- Remove the mounting brackets from the headrail by pushing the back of the bracket forward and up with your thumb.

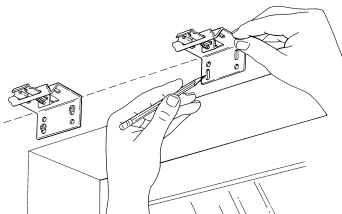

- Mount each bracket making sure all brackets are installed level and in line with each other.

NOTE: Blinds UNDER 60" wide require two screws per bracket. Screws should be mounted diagonally from one another. Blinds OVER 60" wide require four screws per bracket.

## Inside Mount Bracket Placement Templates

Select the template that corresponds with the size of the blind you purchased.

Blind Width	Template
10 1/2" - 13"	A
13 1/8" and up	B

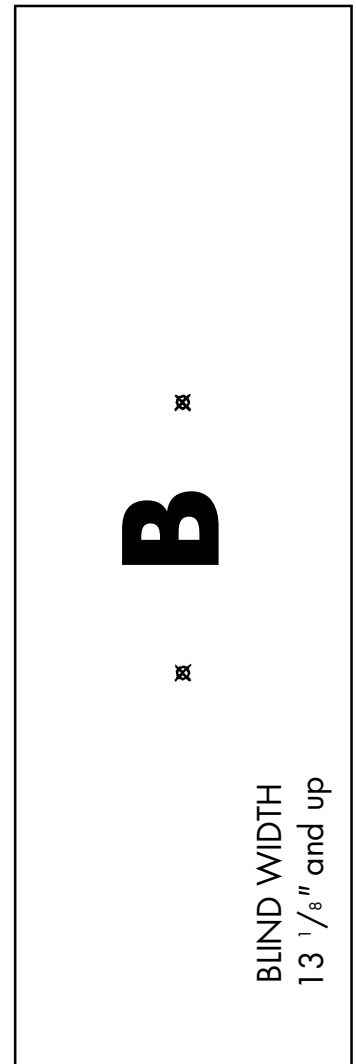
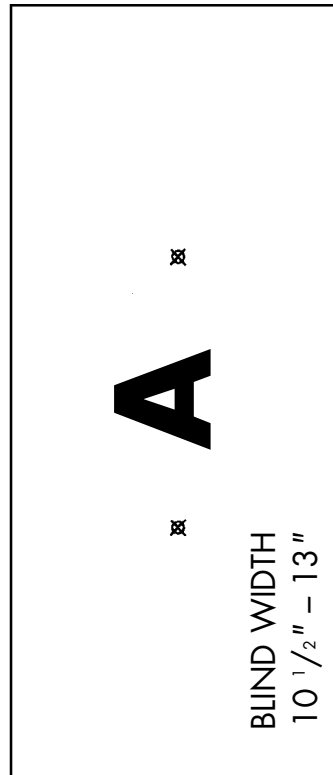

## Blind Installation

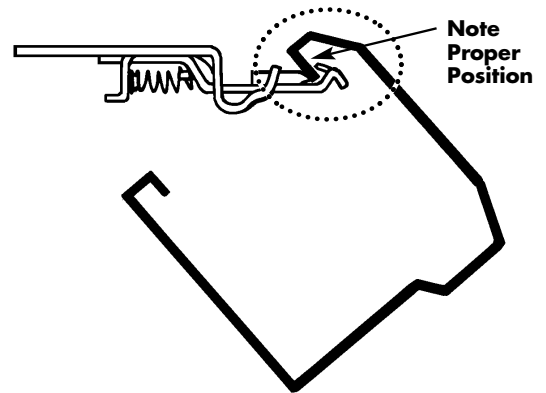

- Hang the front lip of the headrail onto the mounting bracket hook.
- Headrail must be positioned between the “teeth” on the front of the mounting bracket.

NOTE: If the bracket interferes with any of the working parts, the incorrect holes of the end mount bracket may have been selected.

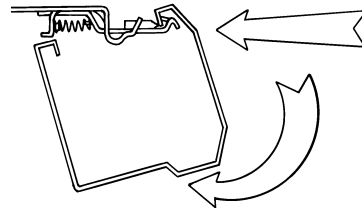

- Push the headrail back while rotating the back of the rail up into the bracket.

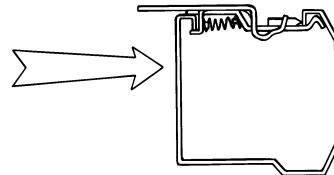

- Pull the headrail forward slightly until it engages into the bracket.

## Blind Operation

To lower the blind, pull the lift cords down and toward the center of the blind and allow the cords to slide slowly through your hand.

To tilt the slats, twist the tilt wand.

Do not attempt to raise or lower the blind unless the slats are in a completely open (horizontal) position.

To raise the blind, pull the lift cords down.

To engage the lock, pull the lift cords down and toward the outside of the blind.

## Blind Removal

Draw the blind completely up.

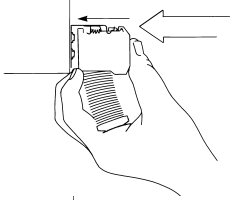

- Push the headrail back toward the wall or window casing to release the back of the headrail from the back of the mounting bracket hooks.

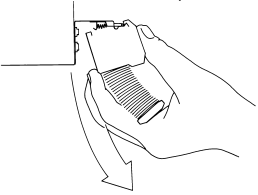

- Rotate the back of the headrail down and carefully lift the headrail off of the front hooks of the mounting brackets.

## Optional Hardware Installation

### Extension Brackets

These are available in two sizes and are used to project the blind up to 3" from the mounting surface. Extension brackets are available at an additional charge and are ideal if your blind must clear an obstruction such as a sliding glass door handle or window crank. Extension brackets require a flat vertical mounting surface of at least 1<sup>3</sup>/<sub>4</sub>".

#### To assemble and mount:

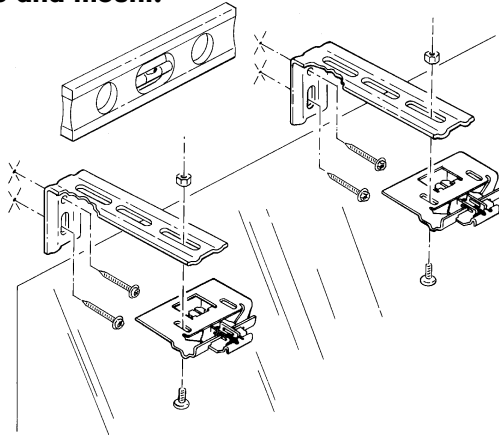

- Attach each mounting bracket to an extension bracket using the nuts and bolts provided.
- Mount the extension bracket to the wall per the instructions for an "Outside Mount" on Page 4, making certain that all mounting brackets are level and project the same distance from the mounting surface.

NOTE: Blinds UNDER 60" wide require two screws per bracket. Screws should be mounted diagonally from one another. Blinds OVER 60" wide require four screws per bracket. Install the blind per the directions for "Blind Installation".

## Spacers

Available for use on windows with a projected molding. They are <sup>3</sup>/<sub>8</sub>" thick and allow the shade to be mounted flush with the outside edge of any standard window molding.

Spacers  
(2 spacers per bracket)

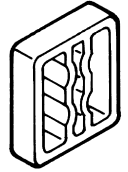

Spacers are available at any 3 Day Blinds showroom free of charge.

## Hold Down Brackets

Hold down brackets are used primarily on shades being mounted to doors or in motor homes. (2 per blind) Hold down brackets are available at any 3 Day Blinds showroom free of charge. There is a small hole in the center of the end cap that is covered by a thin plastic cover. Use the pin of the hold down bracket to push through the center of the end cap and it will break through the plastic cover.

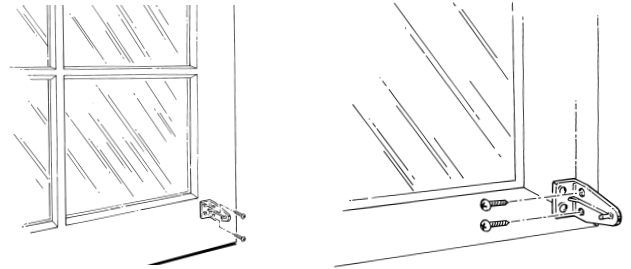

- With the blind lowered to its full length, place the pin of each hold down bracket into the hole in each end of the bottom rail.
- Using a pencil, mark the mounting surface through the holes in the hold down bracket. Make sure the hold down brackets are level and aligned with each other.
- Raise the blind and screw the hold down brackets into the mounting surface using the screws provided.
- Mount the hold down to the side or back of the window frame so that the pin lines up with the front hole in the bottom rail end cap with the blind fully lowered.
- Lower the shade and flex the hold down bracket outward so that the pin can be inserted into the hole in the end cap.

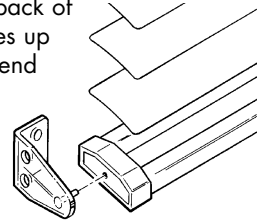

## Care & Cleaning

Caring for your blind is very easy. Simply dust on a regular basis using a soft cloth or a lamb's wool duster. For sticky residue, a mild non-abrasive hard surface cleaner is recommended. Ultra-sonic cleaning is not recommended. 3 Day Blinds also offers a liquid cleaner especially made for blinds. See your local 3 Day Blinds showroom for details.