

# Top Mount Mini Blind Installation Instructions

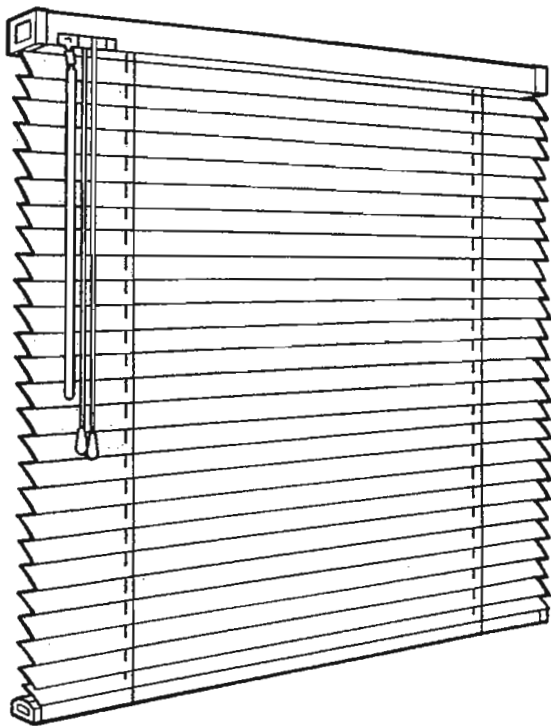

*Transitions® 8  
Essentials.*

Congratulations on the purchase of your new window covering! Aluminum mini blinds are an attractive choice for your home. Included with your purchase is all of the hardware you will need to successfully install your new blind. Please take a moment to read through these instructions before starting.

**3 DAY BLINDS®**

*America's Window Covering Specialists® Since 1978*

1-800-800-3DAY

[www.3day.com](http://www.3day.com)

# Getting Started

## A few simple tools are required:

- Steel tape measure
- Power drill and drill bits (if desired)
- Flathead and Phillips screwdriver
- Pencil
- Level (for outside mount)
- Awl (or tool for starting a screw hole)

Included in your order is all the hardware necessary for a normal installation. Depending on the mounting surface, fasteners other than the screws provided may be required. Wall board and plaster require the use of anchors such as expansion or toggle bolts. Bricks, tile or stone need special plugs and drill bits. Wood should always be pre-drilled to avoid splitting.

Professional installation is also available at most 3 Day Blinds locations.

## Standard Hardware

Mounting Bracket  
(Open Position)

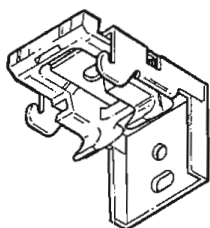

Screws



Double  
Valance Clip

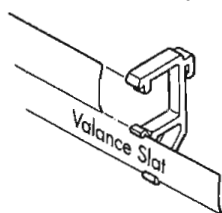

Single  
Valance Clip

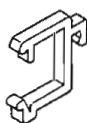

## Optional Hardware

Extension  
Bracket

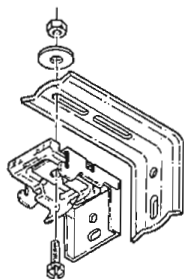

Hold Down  
Bracket

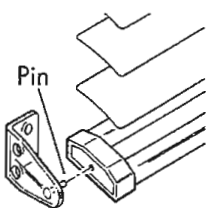

Spacer

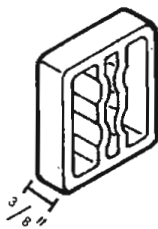

## Bracket Information

You will be using your blind with mounting brackets attached to the headrail to mark the position of the brackets inside your window casing. Unwrap the cellophane from around the blind stack. DO NOT CUT the cellophane as the cords or ladders supporting the blind may be inadvertently cut. Make sure that the plastic caps remain on the headrail.

Blind Width	Number of Brackets
10" - 44"	2
44 1/8" - 67"	3
67 1/8" - 92"	4
92 1/8" - 120"	5

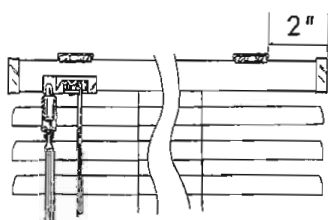

- Clip one mounting bracket directly over the cord lock on the headrail.
- Clip another mounting bracket approximately 2" in from the other end of the headrail.

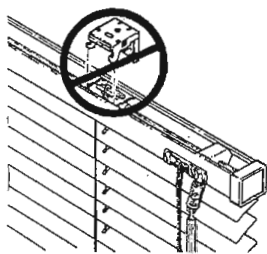

- Additional mounting brackets, if required, should be evenly spaced between the two end brackets.
- Make sure brackets do not interfere with any moving parts in the headrail.

**NOTE:** If using extension brackets, attach mounting brackets to extension brackets with nuts and bolts before attaching brackets to headrail. (See "Optional Accessories" on Page 5.)

## Inside Mount

1 1/8" of window opening depth is required to flush mount a Transitions or Essentials Mini Blind.

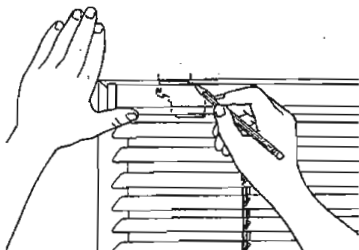

- With mounting brackets attached to the headrail (see Bracket Information), hold the blind up to the desired mounting position and flush with the front edge of the window casing
- Mark the window casing on either side of each mounting bracket.

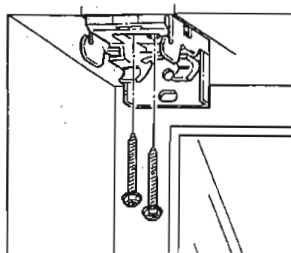

- Remove all of the brackets from the headrail. See "Blind Removal" on Page 4.
- Mount each bracket with two screws.
- Make sure that all brackets are installed straight and in line with one another.

Proceed to "Blind Installation" below.

## Outside Mount

1" of flat mounting surface is required to mount your Transitions or Essentials Mini Blind.

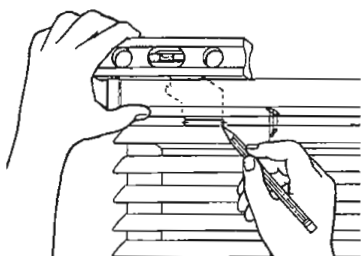

- With mounting brackets attached to the headrail (see Bracket Information), hold the blind up to the desired mounting position over the window. Once the blind is level, mark the wall or molding on either side and the bottom edge of each mounting bracket.

Remove all of the brackets from the headrail. (See "Blind Removal" on Page 4.)

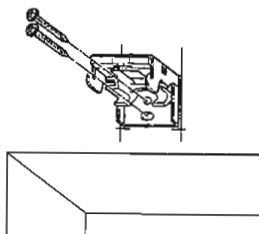

- Mount each bracket with two screws.
- Make sure that all brackets are installed straight and in line with one another.

Proceed to "Blind Installation" below.

## Blind Installation

If you have not already done so, unwrap the cellophane from around the blind stack. DO NOT CUT the cellophane as the cords or ladders supporting the blind may be inadvertently cut.

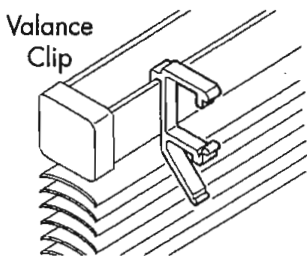

- Snap the valance clips to the front of the headrail before installing the blind. Clips should be evenly spaced across the headrail to allow proper support for the entire valance. You will install the valance slats after the blind is in place.

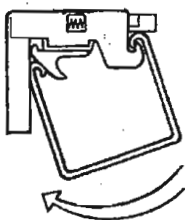

- Hook the front edge of the headrail onto the mounting bracket hooks
- Rotate the headrail up and back until it snaps into the mounting brackets.

## Valance Installation

Make sure the valance clips have been attached to the headrail as noted in "Blind Installation" on Page 3.

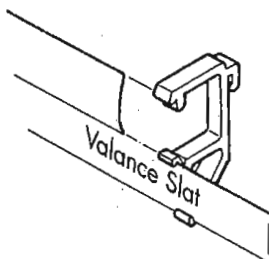

- Beginning at one end of the headrail, slide the end of the valance slot into the valance clips and center the slot on the blind.
- Repeat this process for the second slot.

## Blind Operation

To lower the blind, pull the lift cords down and toward the center of the blind and allow the cords to slide slowly through your hand.

To tilt the slats, twist the tilt wand.

Do not attempt to raise or lower the blind unless the slats are in a completely open (horizontal) position.

To raise the blind, pull the lift cords down.

To engage the lock, pull the lift cords down and toward the outside of the blind.

## Blind Removal

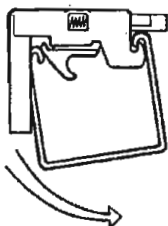
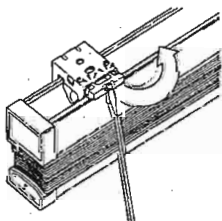

- Insert a narrow flathead screwdriver into the small slot on the underside of the plastic slide of the mounting bracket.
- Gently pull forward and up until the plastic slide snaps into the open position.
- Rotate the back of the blind downward and carefully lift the headrail off of the front hooks of the mounting brackets.

# Optional Accessories

**Extension Brackets** — These are available in two sizes and are used to project the blind up to 3" from the mounting surface. Extension brackets are available at an additional charge and are ideal if your blind must clear an obstruction such as a sliding glass door handle or window crank. Extension brackets require a flat vertical mounting surface of at least 1 <sup>3</sup>/<sub>4</sub>".

## To assemble and mount:

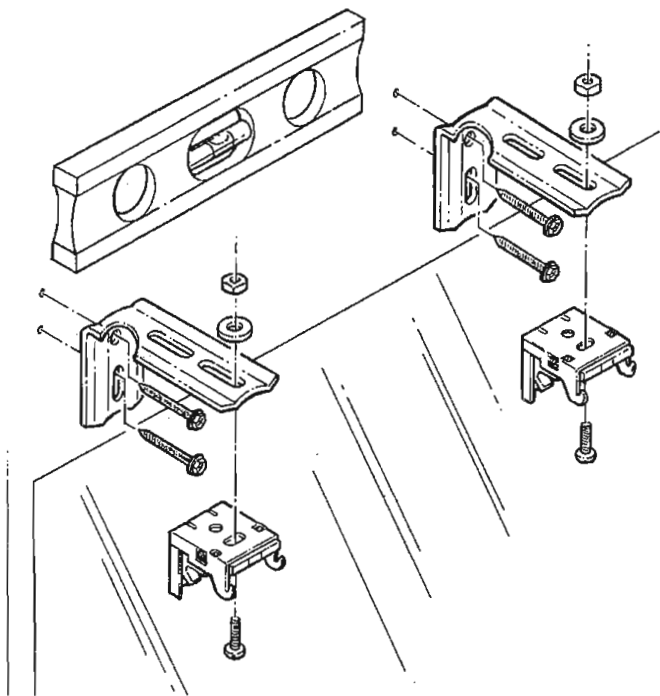

- Attach each mounting bracket to an extension bracket using the nuts, bolts, and washers provided.
- Mount the extension bracket to the wall per the instructions for an "Outside Mount" on Page 3 using a level and making certain that all mounting brackets are level and project the same distance from the mounting surface. For maximum stability, install the screws diagonally from one another.
- Install the blind per the directions for "Blind Installation" on Page 3.

**Spacers** — Available for use on windows with a projected molding. They are <sup>3</sup>/<sub>8</sub>" thick and allow the shade to be mounted flush with the outside edge of any standard window molding. They are free of charge and are available at any 3 Day Blinds showroom.

**Hold Down Brackets** — Used primarily on blinds being mounted to doors or in motor homes. They are free of charge and are available at any 3 Day Blinds showroom. There is a small hole in the center of the end cap that is covered by a thin plastic cover. Use the pin of the hold down bracket to push through the center of the end cap and it will break through the plastic cover.

**To install the hold down brackets:**

- With the blind lowered to its full length, place the pin of each hold down bracket into the hole in each end of the bottom rail.
- Using a pencil, mark the mounting surface through the holes in the hold down bracket. Make sure the hold down brackets are level and aligned with each other.
- Raise the blind and screw the hold down brackets into the mounting surface using the screws provided.

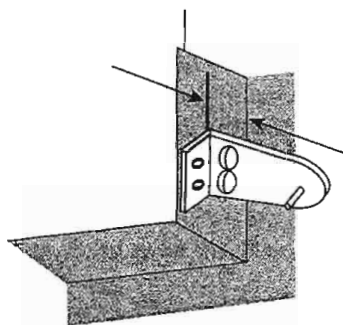

- Mount the hold down to the side or back of the window frame so that the pin lines up with the front hole in the bottom rail end cap with the blind fully lowered.

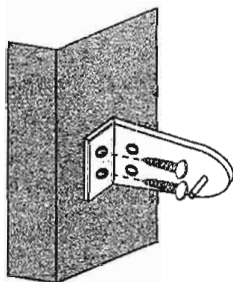

Lower the shade and flex the hold down bracket outward so that the pin can be inserted into the hole in the end cap.

## Care & Cleaning

Caring for your blind is very easy. Simply dust on a regular basis using a soft cloth or a lamb's wool duster. For sticky residue, a mild non-abrasive hard surface cleaner is recommended. Ultra-sonic cleaning is not recommended. 3 Day Blinds also offers a liquid cleaner especially made for blinds. See your local 3 Day Blinds showroom for details.



## WARNING



Young children can strangle in cord and bead chain loops. They can also wrap cords around their necks and strangle.

- Always keep cords and bead chains out of children's reach.
- Move cribs, playpens, and other furniture away from cords and bead chains. Children can climb furniture to get to cords.
- Do not tie cords together. Make sure cords do not twist together and create a loop.

## Limited Lifetime Warranty

3 Day Blinds, Inc., will repair or replace any part of the blind found to be defective in materials or workmanship at no cost to you. This warranty is limited to the original consumer purchaser of the blinds. There is no time limit to our warranty, excluding Essentials® line products which come with a 1 year limited warranty. This warranty does not apply to any defect caused by improper installation, alteration, abuse, misuse or exposure to excess moisture. This warranty does not cover normal wear and tear such as the natural deterioration of fabric and changes in color that take place over time. This warranty does not cover products that exceed 3 Day Blinds' size recommendations. To obtain service, bring the product(s) in question to any 3 Day Blinds store with this warranty and your purchase invoice. This warranty gives you specific legal rights and you may also have other rights which vary from state to state.

# **3 DAY BLINDS®**

*America's Window Covering Specialists® Since 1978*

1-800-800-3DAY

[www.3day.com](http://www.3day.com)

PART #00001-020/000-042 REV 10-04

© COPYRIGHT OCTOBER 2004

3 DAY BLINDS, INC.